

# Diplomat 2007

## Water Systems — Section 6

<b>WATER SYSTEMS - INTRODUCTION</b> .....	128	<b>ELECTRIC TOILET (40 SKT &amp; 40 DFT MODELS ONLY)</b> .....	137
<b>WATER TANKS</b> .....	128	Operation .....	137
Measurements & Calibration .....	128	Programming the Water Level .....	137
Fresh Water Fill .....	128	Holding Tank Level Sensors .....	137
<b>WATER TANK - FRESH GRAVITY FILL</b> .....	129	Cleaning .....	138
City Water Hook-up .....	129	Maintenance .....	138
<b>WATER PUMP</b> .....	129	Winterization .....	138
Water Pump Troubleshooting .....	130	Drain Traps & Auto Vents .....	138
<b>WATER FILTER - FAUCET</b> .....	130	<b>COLD WEATHER CONDITIONS</b> .....	139
<b>WATER SYSTEMS</b> .....	131	Cold Weather Storage .....	139
Troubleshooting .....	131	<b>WINTERIZATION</b> .....	139
Disinfecting Fresh Water .....	131	Using Air Pressure .....	140
<b>FAUCET SCREENS</b> .....	132	Using Non-Toxic Antifreeze and Gravity Fill .....	140
<b>WASTE WATER SYSTEMS</b> .....	132	Dewinterization .....	141
Proper Waste Disposal .....	132	<b>WATER SERVICE CENTER</b> .....	142
What Not to Put in Waste Holding Tanks .....	132		
What to Put in Holding Tanks .....	133		
Waste Drain Hose .....	133		
Tank Flush .....	134		
<b>WASTE PUMP (OPTIONAL)</b> .....	134		
<b>TOILET (NOT ON ALL UNITS)</b> .....	136		
Cleaning & Maintenance .....	136		

## WATER SYSTEMS - INTRODUCTION

This section contains information about the operation and care of various water system equipment found in the motorhome. Optional water equipment will also be discussed, so not all information may be applicable to each motorhome. More detailed information with **CAUTION** or **WARNING** instructions for various equipment, other than what is found in this section, can be found in the OEM manuals in the owner information box.

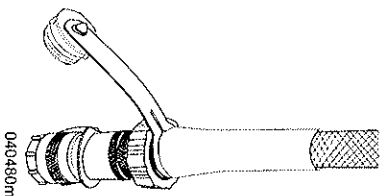

It is hard to imagine how much water is used by the average person. Newcomers to a self-contained motorhome soon discover water does not last long unless consumption is drastically reduced. For example, less water can be used for showering if the shower is turned off while soaping down, then turned back on to rinse. This way a good shower uses a couple gallons of water or less. There is plenty of water to meet personal needs once habits are adjusted.

### Fresh Water System:

The fresh water system consists of a fresh water tank, water pump, gravity fill connection, water filter and a city/fresh water connection. Use

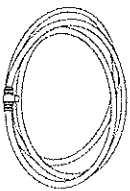

a water hose that is marked for potable water use only. Proper care of the hose is necessary. After each use, drain the water hose and coil the hose neatly. Attach the ends together to keep dirt, debris and insects out of the hose. If the

motorhome has the optional electric hose reel, the hose will be included. Coiled the hose on the reel after each use.

### Waste Water System:

The waste water system consists of a waste holding tank (grey water), sewage holding tank (black water), flush system, toilet and drains.

### WARNING

Water is electrically conductive. **DO NOT use any electrically powered item or electrical outlet that may be exposed to a water source. Such use can result in a serious shock, causing injury or death.**

## WATER TANKS

### Measurements & Calibration

The motorhome is equipped with a monitor panel to aid in managing the storage tanks. The monitor panel is located on the Systems Control Center in the hallway area. A second optional monitor panel is located in the roadside water service center. The switch marked Test is a momentary switch which requires being held down while testing the level of the storage tanks. Read the scale for the desired storage tank that is being monitored. Each scale uses colored lights along with a corresponding scale reading. The lights and scale are as follows:

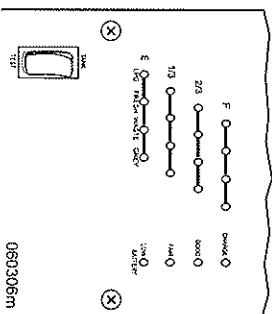

Monitor Panel  
Located in Hallway Area

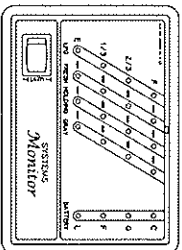

Monitor Panel (Optional)  
Located in Service Center

LP Tank and Fresh Tank	Holding and Grey Tanks
Red = Empty	Green = Empty
Orange = 1/3 Full	Yellow = 1/3 Full
Yellow = 2/3 Full	Orange = 2/3 Full
Green = Full	Red = Full

### Fresh Water Fill

When connecting the motorhome to fresh water, use a hose manufactured and labeled "for potable water." This ensures that the hose will not flavor the water. It is recommended to install a pressure regulator on the water line. On hot days the hose may expand and burst from excessive pressure within the hose.

1. If the motorhome has the optional Power Hose Reel, pull hose out. Connect one end of the pressure regulator to the water source and the other end to the hose and go to step #4. If motorhome does not have the optional power hose reel, proceed with step #2.
2. Connect one end of the pressure regulator to the water source and the other end to the hose.

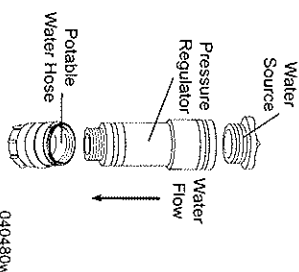

### CITY WATER

### TANK FILL

0404800

3. Connect hose to the City/Fresh Water Fill valve located in the roadside water service center.
4. Make sure the fresh water tank drain valve, located in the roadside water service center, is in the closed position.
5. Turn the water control valve to the "Tank Fill" position.
6. Turn on water at the water source. The water should be audible as the fresh water tank fills. Monitor the tank filling by using monitor panel located inside the motorhome, or the (optional) monitor located in the roadside water service center.
7. Frequently press the "Test" switch and read the scale as the fresh water tank fills. Do not leave the motorhome unattended while filling the fresh water tank.
8. The tank is nearing full when the light marked "F" illuminates. When the tank is completely full, water will flow out an overflow tube under the motorhome.
9. Turn off water supply and return the water control valve to "City Water" position.
10. Disconnect the potable hose. Remove pressure regulator. Store the hose with both ends connected to prevent debris from entering the hose.
11. If applicable, activate the (optional) power hose reel switch to coil the hose on the reel.

## WATER TANK - FRESH GRAVITY FILL

The gravity fill inlet allows fluids to be introduced directly into the fresh water tank. Water can be poured directly from a container into the fresh water tank. The gravity fill inlet can be used to pour disinfecting solution into the fresh water tank or when using potable RV antifreeze to winterize the fresh water system. Use only potable water sources, solutions and delivery systems when using the gravity fill inlet.

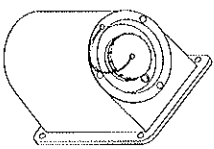

040406  
Located in the roadside water service center

### Filling the Tank:

1. Unscrew fill cap taking care to keep cap and inlet clean.
2. Insert potable water hose into inlet.
3. Fill tank until water overflows from inlet.

### NOTE

When filling tank do not leave hose unattended.

## City Water Hook-up

When connecting the motorhome to fresh water, use a hose manufactured and labeled for potable water to ensure the hose will not flavor the water.

1. If the motorhome has an optional hose reel, pull hose out. Connect the pressure regulator to the water

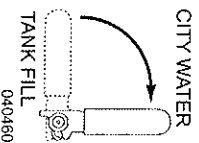

040460p

- source and the other end to the hose and proceed to #4. If motorhome does not have reel, proceed to #2.
2. Install one end of the pressure regulator to the water source and the other end to a potable hose.
  3. Connect the other end of the potable hose to the City/Fresh Water Fill inlet.
  4. Water control valve should be in the "City Water" position.
  5. Turn on the water at the water source.
  6. The water pump can either be OFF or ON. It will not affect the water pump to leave it on.
  7. Open each faucet, one at a time, to rid any trapped air inside the pipes.

### CAUTION

Some water sources develop high water pressure, particularly in mountainous regions. High water pressure is anything over 55 psi (pounds per square inch). Excessive water pressure may cause leaks in water lines and/or damage the water heater.

## WATER PUMP

The water pump pressurizes the fresh water system when not connected to city water. The water pump is self-priming, operating on demand as water is used. The water pump is located in the water service center.

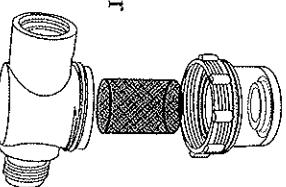

040586  
Water pump inlet screen: Located on water pump in water service center. Clean every two months.

To operate the water pump the house battery disconnect switch and battery cut-out switch must be on.

### **WARNING**

Before leaving the motorhome for extended periods of time (i.e. overnight or longer) be sure that the city water supply and water pump have been turned off. Damage from neglect will be the responsibility of the owner, not the manufacturer.

The water pump can be operated from these following locations:

- ◆ Hallway Systems Control Panel
- ◆ Water Service Center
- ◆ Kitchen Area

To turn the water pump ON or OFF:

- ◆ Momentarily press the water pump switch. The indicator lamp illuminates when the water pump is turned on.

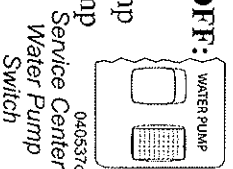

### **CAUTION**

DO NOT continue water pump operation if the fresh water holding tank is empty. Damage to the water pump or electrical supply system may result.

To operate the water pump after unhooking from a city water supply or after storage:

- ◆ Close all drain valves and low point drains.
- ◆ Fill the fresh water tank.
- ◆ Open the hot and cold water valves of each faucet.
- ◆ Turn the water pump ON. Wait for the water lines and the hot water tank to fill.

- ◆ Close each faucet when it delivers a steady stream of water (cold water faucets first).

### **Water Pump Troubleshooting**

Vibration induced by road conditions can cause the plumbing or pump hardware to loosen. Check the water pump system for components that are loose. Many symptoms can be resolved by tightening the hardware. Check the following items:

**Water pump will not start or blows the fuse:**

- ◆ Check the electrical connections, fuse or breaker, main switch and ground connection.
- ◆ Is voltage present at the pressure switch on the pump? If voltage is present, the pressure switch may be faulty. As a test, temporarily bypass the pressure switch.
- ◆ Check the charging system for correct voltage and good ground.
- ◆ Check for an open or grounded circuit or motor.
- ◆ Check for a seized or locked diaphragm assembly (water frozen).

**Water pump will not prime or sputters**

(No discharge/motor runs):

- ◆ Is the pump inlet strainer clogged with debris?
- ◆ Is there water in the tank or has air collected in the water heater?
- ◆ Is the inlet tubing and plumbing sucking in air at plumbing connections (vacuum leak)?

- ◆ Check for proper voltage with the pump operating.
- ◆ Check the pump housing for cracks or loose drive assembly screws.

**Water pump will not shut-off or continues to run when the faucet is closed:**

- ◆ Check to see if the fresh water/tank fill valve is completely closed.
- ◆ Check the output (pressure) side plumbing for leaks and inspect for a leaky toilet or valves.
- ◆ Look for a loose drive assembly or pump head screws.

**Water pump is noisy or rough in operation:**

- ◆ Check for plumbing that may have vibrated loose.
- ◆ Does the mounting surface multiply noise (flexible)?
- ◆ Check for mounting feet that are loose or compressed too tight.
- ◆ Look for loose pump head to motor screws.

**Water pump is rapid cycling:**

- ◆ Look for restrictive water flow in the faucets or shower heads.

### **WATER FILTER - FAUCET**

The motorhome is shipped with a diverter hose in place of the in-line faucet water filter. For winterization purposes the diverter hose will have to be installed in place of the filter. To initially install a water filter or to replace a water filter, use the procedure as follows:

- Locate the water filter diverter hose under the galley sink area.
- Remove the top and bottom fittings from either the hose or filter.
- Connect top and bottom fittings to the filter to purify the system.
- Store diverter hose for use when winterizing the water system.

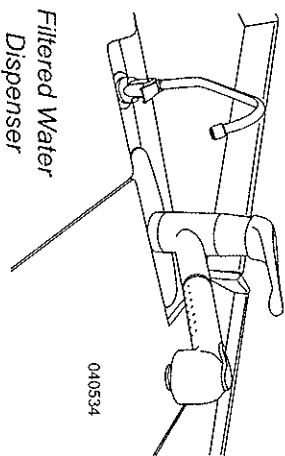

**CAUTION**  
When flushing the water lines and after all the antifreeze has been flushed from the water system **REMOVE** the diverter. The diverter **IS NOT** intended for sustained use in normal water system operation.

A fresh replacement cartridge is needed when the flow of water from the faucet becomes slow. The life of the filter depends upon incoming water conditions and water consumption. As water passes through the water filter, dirt particles are trapped in the tiny pores of the micro-pure coating on the filtering element inside the cartridge. As the cartridge removes impurities from the water, microscopic pores slowly permeate and the amount of water flowing from the cartridge gradually decreases.

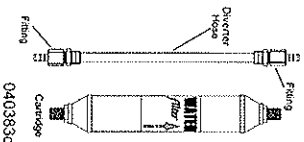

When the flow of water becomes too slow for convenience the filter requires servicing. If the cartridge is not changed the flow will eventually stop. It is recommended the filter be replaced at least once a year for continued reliable performance from the purification system.

**NOTE**  
Change the filter every six months.  
Replace with Flow-Pur Filter Cartridge FP 10GT.

### WATER SYSTEMS Troubleshooting

Water pump cycling after closing the faucets, drain valves and inlet valves, may indicate a leak. Check for leaks around fittings, valves, filters, and connections of the hot and cold water system. If problems continue take the motorhome to an authorized dealer for repair.

#### Disinfecting Fresh Water

Disinfecting the water system with household bleach (sperchlorination) protects against bacteriological or viral contamination from common water sources.

- Disinfect the fresh water system:**
- ◆ If the motorhome is new.
  - ◆ If the motorhome has been in storage.
  - ◆ Every three months during use.

**NOTE**  
Use the gravity fill to perform this task. Remove cap from the gravity fill. Add the solution. When finished, secure the gravity fill cap.

Use following procedure to disinfect water system:

- ◆ Replace the faucet water filter with the diverter hose (see "Faucet Water Filter").
- ◆ Prepare a household chlorine bleach solution of 1 gallon water and ¼ cup of chlorine bleach. Use 1 gallon of solution for every 15 gallons of tank capacity. E.g.: Add 2-2/3 gallons solution to a 40 gallon tank. This mixture puts a 50 ppm (parts per million) residual in the water system, and acts as a quick-kill dosage for harmful bacteria, viruses and slime-forming organisms. Concentrations higher than 50 ppm may damage the water lines and/or tanks.
- ◆ Turn the water pump **OFF**.
- ◆ Drain the fresh water tank. Water tank drain is located in the roadside water service center. Close the drain and pour the solution into the fresh water tank using the gravity fill and a funnel.
- ◆ Turn the water pump **ON**. Open each faucet, in turn, and run the water until you smell a distinct chlorine bleach odor. Do not forget the hot water, tub and shower faucets.
- ◆ Allow the system to stand for 4 hours.

- ◆ Drain the system and flush with fresh water. The water tank and low point drains are located in the roadside water service center. Flush with fresh water repeatedly, until the water system no longer smells or tastes like chlorine bleach.
- ◆ Install new faucet water filter.

**TIP**

Use the same hose labeled for potable water to introduce the chlorine solution into the system. This will disinfect the potable water hose at the same time. Several flushes will be required to remove chlorine residue from the potable hose.

**INFORMATION**

Household bleach is 5.25% Sodium Hypochlorite. Higher concentration will increase PPM ratio.

**FAUCET SCREENS**

Fresh water sources will vary by location.

Build up of lime deposits, or debris on the faucet screen, will restrict or plug the flow of water coming from the faucets. Should the flow of water reduce, the filter screen in the faucet head may be clogged. All faucet screens should be checked and cleaned every two weeks of use.

- ◆ Faucet screens are normally located on the outlet side of the faucet and held in place with a threaded collar.
- ◆ Remove screen from faucet.

- ◆ Clean screen using a small soft brush and de-liming solution.
- ◆ Reinstall screen and check water flow.

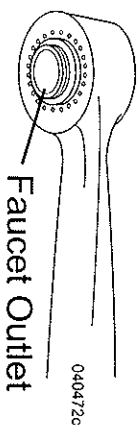

Faucet Screen

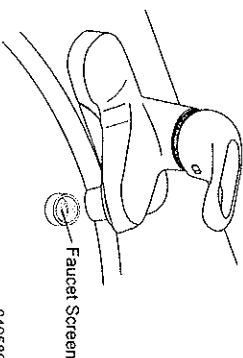

Typical Water Faucet

**WASTE WATER SYSTEMS****Proper Waste Disposal**

Dumping raw sewage from toilet holding

tanks, except at authorized dumping stations, is universally prohibited. Most National, State and private parks have either a central dump facility or campsite hook-up for sewage. Many modern rest areas along the interstate now have dump stations available. Woodall's Campground Directory, Trailer Life's RV Campgrounds and Services Directory, Rand McNally's Campground and Trailer Park Guide, Good Sam Park Director (Good Sam Club) and other similar publications list dumping stations. Some major oil companies offer dump facilities at selected stations also.

**What Not to Put in Waste Holding Tanks**

- ◆ **DO NOT** use strong or full strength detergents to deodorize and disinfect. Use odor control chemicals made especially for holding tanks.
- ◆ Automotive antifreeze, ammonia, alcohol or acetone in holding tanks will dissolve plastic.
- ◆ **DO NOT** dispose of table scraps or cooking grease into the tanks. They can clog pipes or damage the valve seals.
- ◆ Facial tissue is thicker, softer and stronger than a rapidly dissolving tissue. White toilet paper dissolves faster than colored. To test tissue dissolving ability, immerse one tissue square into a jar of water. Shake the jar five times to determine how the tissue disintegrates.
- ◆ **DO NOT** use any type of tissue that remains in one piece. Paper designed specifically for holding tanks is available at most RV supply stores.

**NOTE**

Never dispose of sanitary supplies or other non-dissolving items into the system. Facial tissue, wet strength tissue, paper towels or an excessive amount of toilet tissue can create clogging in the holding tank system.

**CAUTION**

**DO NOT** use any products that contain petroleum distillate or ammonia in place of RV odor controlling chemicals. Petroleum distillate or ammonia will damage the ABS plastic holding tanks and seals.

### What to Put in Holding Tanks

#### Grey Water Tank:

The grey water waste tank stores the sink, shower and clothes washer (if equipped) drain water. A reduced mixture of chemicals may help to control odor in the grey tank.

Ensure that there is enough liquid in the holding tanks prior to dumping the waste holding tanks to provide a smooth flow through the valve, drain pipe and drain hose. Empty the waste holding tanks weekly to prevent stagnation and overflowing.

#### Black Water Tank:

Before initially operating the toilet, treat the sewage holding tank with a pre-charge of water and an odor-control chemical (available at most RV supply stores). First, add approximately three gallons of water to the holding tank. Next, mix the chemicals, in accordance with the manufacturer instructions, with approximately one gallon of water. Pour mixture through toilet to the holding tank. Be careful not to spill the chemical on hands, clothing, toilet bowl or carpet. Hot weather conditions may require adjusting the amount of chemical used to control odor. Repeat the chemical pre-charge to the holding tank each time the tank is cycled.

#### WARNING

Most chemical mixtures for holding tank odor control are poisonous. Follow the product manufacturer's directions and warnings when using holding tank additive. **DO NOT** use any products that contain petroleum distillate or ammonia in place of RV odor controlling chemical. Petroleum distillate or

ammonia will damage the ABS plastic holding tanks and seals.

#### Waste Drain Hose

A flexible three-inch sewer hose attaches between the termination drain and the shore facility. Sewer hoses usually come in 10 or 20 foot lengths.

The shore fitting for the sewer hose may be a three or four-inch, male or female thread pipe; or a four-inch pipe with no threads, covered by a metal plate. Different style of adapters are available to fit most configurations. Hose ladders may also be purchased to support the hose.

It is important that the hose remains secure.

**Always tighten clamps and restraining devices before use.** Lay the hose inline between the termination outlet and the shore fitting. Restrain the hose to prevent movement during use. Wear protective and/or disposable gloves when handling the sewer hose.

#### To Attach the Hose:

- ◆ Remove termination cap. Align coupler tangs with termination tabs. Twist coupler clockwise 90° locking coupler to termination outlet.
- ◆ Attach other end of hose to drain service. Restrain hose to prevent movement during use.
- ◆ Open the (small) grey water valve.

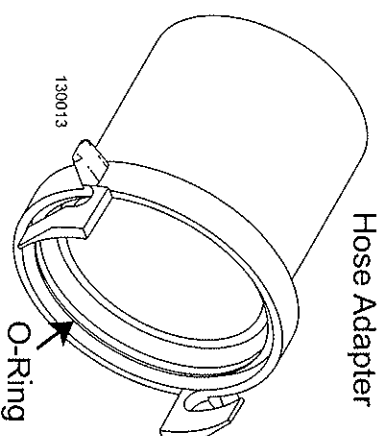
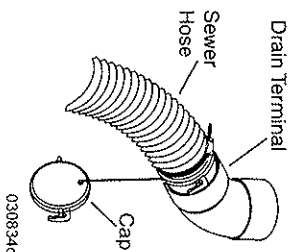

The large black water valve remains closed until the tank is full or until time of departure to help prevent clogging. Use the outside faucet or shower attachment for washing or rinsing the sewer hose after dumping the black tank.

#### NOTE

Use care when connecting the sewer hose adapter to the termination outlet in cold weather.

#### NOTE

Close the grey water valve 24 hours prior to departing to allow the tank to fill with liquid to help in the dumping process.

#### LUBE

Periodically lubricate the O-ring on the sewer hose adapter with silicone spray.

### Tank Flush

The motorhome comes equipped with a power flush nozzle, located in the black tank to help reduce solids build-up. Flush the black tank each drain cycle. Failure to thoroughly rinse the black tank may result in accumulated solids and a clogged spray nozzle.

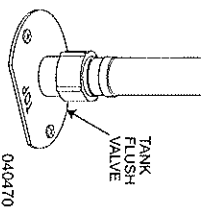

- Gravity Drain Hose Dumping:**
1. Attach sewer hose to terminal drain and shore facility.
  2. When preparing to dump the black tank, first close the grey water valve.
  3. Fill the grey tank to at least 50% by running water in the shower or sinks.
  4. Use the monitor panel to observe tank fluid levels. When the grey tank is 50% full, stop filling.
  5. Open the black water valve. Allow the black tank to drain.

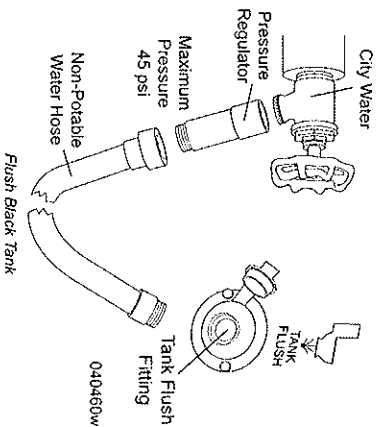

6. Connect a non-potable water hose, with pressure regulator, to the tank flush fitting located in the water service center.
7. Turn on the faucet and allow water to rinse the black tank at least three minutes. Never operate the system unattended. Ensure the water flows freely though the drain hose.
8. When completed, turn off the faucet and close the black water valve.
9. Open the grey water valve. The water in the grey tank will flush remaining solids from the hose. With the grey water valve open, run two gallons of water down any drain to flush grey tank. The grey valve remains open until the next drain cycle, or time of departure.

#### **WARNING**

Never operate the flush system unattended. Flooding may occur. Use the tank flush system each time the holding tanks are cycled. Failure to routinely use the flush system will result in a clogged spray nozzle. Turn off the water supply when finished flushing the tank.

10. When preparing for travel, close both dump valves. Undo restraining devices from the hose. Disconnect the hose from the termination outlet by rotating the fitting counterclockwise 90°.
11. Raise the hose and drain using hand over hand method working the hose towards shore fitting. Rinse the hose with outside facility and repeat the hose drain process.

12. Remove the hose from shore fitting. Install hose in carrier and lock door. Secure the termination cap (required by law in some states).
13. If desired, add chemicals to the tanks to control odor. Follow the directions given by the manufacturer of the chemical.

#### **NOTE**

Dump the black tank before driving.

### WASTE PUMP (OPTIONAL)

The Sani-Con waste pump is a self-priming impeller pump designed to minimize clogging when draining the tanks. The Sani-Con system comes with a 1 1/2" outlet hose with sewer pipe adapter and a 13 gallon per minute macerator pump. The house battery disconnect switch must be on for the Sani-Con system to operate.

#### Prepare the Sani-Con Pump for Use:

- ◆ Make sure the black tank (solid waste water) and grey tank (liquid waste water) valves are closed.
- ◆ Remove the terminal drain outlet cap. Secure the 3" flexible sewer hose from the Sani-Con macerator pump to the termination drain outlet by aligning the sewer hose coupler tangs with the terminal tabs. Twist the coupler clockwise to lock it to the terminal outlet.
- ◆ Remove the drip cap from the Sani-Con discharge nozzle.



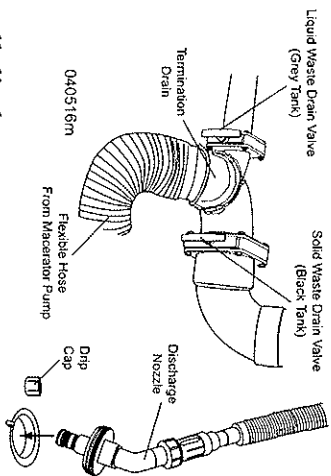

- ◆ Install discharge nozzle to the shore drain. Adapters allow the discharge nozzle to be adapted from 3" to 3½" and 4" threaded sewer connections. Thread the red adapter into the sewer connection, and press the threaded end of the sewer hose into the adapter. Ensure the hose end is installed correctly prior to operation.

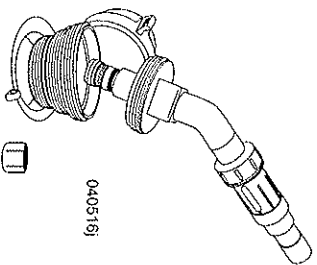

- ◆ Turn on the chassis battery disconnect. The Sani-Con pump operates on 12 Volts from the chassis battery.
- ◆ If desired, the grey tank (liquid waste water) valve can be opened while the discharge nozzle is attached to the shore drain. Water used from the sinks, shower and clothes washer will drain through the bypass hose into the shore drain.

#### To Empty the Grey Tank (Liquid Waste Water):

- ◆ Secure the 3" flexible hose from the Sani-Con pump to the termination drain on the dump connection.

- ◆ If applicable, close the black tank (solid waste water) valve.
- ◆ Open the grey tank valve (liquid waste water).
- ◆ Turn on the Sani-Con pump using the Sani-Con switch on the water service center panel. Allow the grey tank to empty.
- ◆ Push the test switch on the monitor panel to read tank levels.
- ◆ If applicable, the black tank (solid waste water) can be emptied at this time.
- ◆ Turn the Sani-Con pump off.
- ◆ Close the grey tank drain valve and, if applicable, the black tank valve.
- ◆ Prepare the Sani-Con pump for travel as desired.

#### To Empty the Black Tank (Solid Waste Water):

- ◆ Make sure the black tank (solid waste water) and grey tank (liquid waste water) valves are closed.
- ◆ Secure the 3" flexible hose from the Sani-Con pump to the termination drain on the dump connection.
- ◆ If applicable, close the grey tank (liquid waste water) valve.
- ◆ Open the black tank valve.
- ◆ Turn on the Sani-Con pump using the Sani-Con switch on the water service center panel. Allow the black tank to empty.
- ◆ Push the test switch on the monitor panel to read tank levels.
- ◆ When black tank is empty turn off the Sani-Con pump.

- ◆ Use the black tank flush system. Connect a non-potable water hose, with pressure regulator, to the water source. Connect the other end of the water hose to the Tank Flush fitting.
- ◆ Turn on the water source and allow the water to rinse the black tank at least three minutes.
- ◆ Turn the water off, disconnect the hose and pressure regulator. Store the hose and regulator for future use.
- ◆ Turn the Sani-Con pump ON and allow black tank to empty. Turn the Sani-Con pump OFF and close black tank drain valve.
- ◆ If applicable, the grey tank (liquid waste water) can be emptied at this time.
- ◆ Prepare the pump for travel as desired.

#### Prepare the Sani-Con Pump for Travel:

- ◆ Make sure the black and grey tank valves are closed.
- ◆ Turn the Sani-Con pump ON for a few seconds to clear any water from the pump inlet hose. Turn the Sani-Con pump OFF.
- ◆ Remove Sani-Con discharge nozzle from the shore drain. Install the drip cap on the Sani-Con nozzle (required by law in some states).
- ◆ Store Sani-Con nozzle and pump discharge hose.
- ◆ If desired, add chemicals to the holding tanks to control odor. Follow the chemical manufacturer's directions.

**Troubleshooting:**

- ◆ The house battery disconnect switch must be on.
- ◆ 12 Volt DC power for the macerator pump comes from the house batteries and is protected with a 20 Amp mini-breaker. The breaker is located in the curbside electrical battery compartment. Open the black box above the batteries to access the mini-breaker. To identify the breaker locate the purple wire or the label.

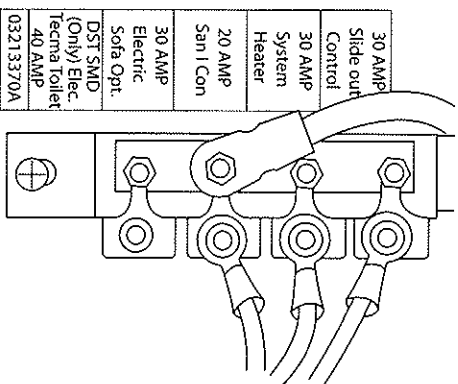

Located in curbside  
battery compartment

060162b

**TOILET (NOT ON ALL UNITS)**

The toilet uses water from either the fresh water tank or a city water supply. The water pump must be turned **ON** or connect the motorhome to city water. The toilet flushes directly into the sewage holding tank (black water).

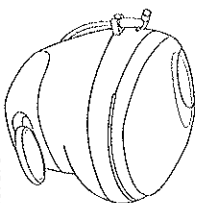

040466

**CAUTION**

To prevent accumulation of solids below toilet, add several gallons of water to the holding tank before use. Most chemical mixtures for holding tank odor control are poisonous. Follow the product manufacturer's directions and warnings when using any holding tank additive.

**NOTE**

Never dispose of sanitary supplies or other non-dissolving items into the toilet. Facial tissue, wet strength tissue, paper towels or an excess toilet tissue can clog the tank or termination valve.

- ◆ To add water to the toilet before using, press and hold the pedal halfway until the desired water level is reached. Generally, more water is required only when flushing solids.
- ◆ To flush the toilet, push the lever all the way down until the sewage leaves the toilet.

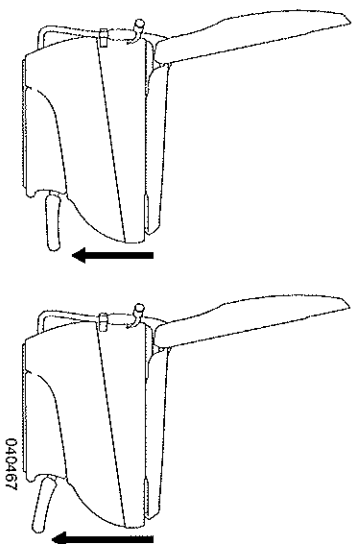

040467

Water flow pressures vary. Therefore, holding the flush lever down for several seconds may be required. Release the flush lever, allowing it to snap back, permitting positive sealing around the flush ball. A small amount of water should remain in bowl.

- ◆ To operate the hand sprayer, depress the thumb lever. Step on foot pedal. Direct water into the bowl.

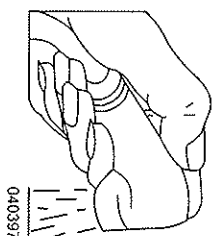

040397

**Cleaning & Maintenance**

The toilet should be cleaned regularly for maximum sanitation and operational efficiency. Clean the toilet bowl with a mild bathroom cleaner. **DO NOT** use chlorine or caustic chemicals, such as drain opening types, as they will damage the seals.

Clean the toilet system using the tank flush. If additional flushing is desired, flush with several gallons of fresh water and one cup of dry laundry detergent. Add odor control deodorant, in the amount specified for the holding tank capacity, every few days during use.

**Maintenance - Checking for Leaks:**

- ◆ **Back of toilet:** Check water supply line connection for tightness. Toilet tissue works well to find leaks. The tissue changes texture when contacting moisture.

◆ **Between closet flange and toilet:**

Confirm that flange screws are snug. **DO NOT** over tighten screws. If leak continues, remove toilet and check flange height. Adjust the flange height to 7/16" above floor, if necessary. Replace flange seal if damaged.

**Maintenance - Bowl Problems:**

◆ **Poor flush:** Flush should be obtained within two to three seconds. If a problem persists, adjust the water level. If problems continue, the water pressure or flow rate may be low. Remove the water supply line and check flow rate. Flow rate should be at least ten quarts (9.5 liters) per minute. Water pressure should not be below 25 psi.

◆ **Bowl will not hold water:** Check for and remove any foreign material from blade seal track. Check blade seal compression with mechanism. If blade seal is worn, replace.

**NOTE**

If the motorhome is in storage for six months, spray silicone on the toilet valve and work it back and forth. Perform this maintenance monthly during use (silicone will evaporate in about 30 days). **DO NOT** use a petroleum-based lubricant, damage to the seals will occur.

**ELECTRIC TOILET (40 SKT & 40 DFT MODELS ONLY)**

The toilet is an electric macerating toilet. To avoid damage only flush organic material and toilet paper. To operate the toilet the house battery disconnect switch must be on.

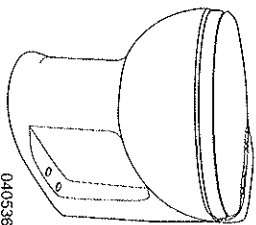

The toilet uses a 40 Amp mini-breaker located in the curbside battery compartment. Open the black box above the batteries to access the mini-breaker.

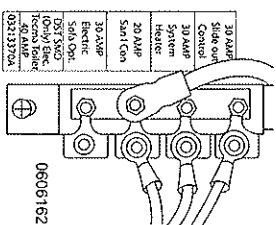

Mini Breaker

**Operation**

To operate the Tecma toilet the house batteries must be on and charged.

**Water Saver Flush:**

◆ Press and release left button. This mode is recommended for flushing liquids and small amounts of toilet paper only.

**Normal Flush:**

◆ Press and release right button. This mode is recommended for flushing solids and toilet paper.

**Empty Bowl:**

◆ Press both buttons simultaneously and release. This empties the bowl and leaves it dry for travel.

◆ Press either button once to add water, run motor, and return to normal use.

**Programming the Water Level**

The water level in the bowl can be programmed. The minimum recommended refill level is 1/2" above the bowl outfall hole. To locate the outfall hole look down into the bowl and the "opening" is the bowl outfall hole.

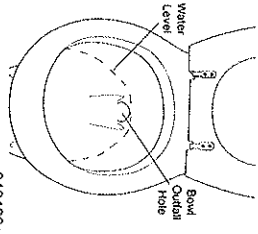

After changing water source from municipal to pump, resetting water may be necessary. To program the water level perform the following steps.

- ◆ Press both buttons and hold.
- ◆ LEDs will flash indicating the toilet is in program mode.
- ◆ As water enters the bowl, release fingers from buttons to set the level of standing water in the bowl. The level set remains constant after each flush until it is changed.

**Holding Tank Level Sensors**

The Tecma toilet system has tank level sensors mounted on the outside of the black tank. On the bathroom control panel is a small water icon located in the bottom right corner. The following information pertains to that water icon.

**Water Icon Not Lighted:**

◆ Toilet system is Off, in sleep mode or not receiving power.

**Water Icon Lighted Green:**

- ◆ Toilet system is On and the holding tank is between empty and half full.

**Water Icon Lighted Yellow:**

- ◆ Toilet system is On and the holding tank is at least half full.

**Water Icon Lighted Red:**

- ◆ Toilet system is On and the holding tank is full.

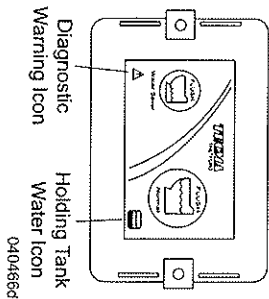
**Full Tank Lockout**

For the safety of the system, the toilet will not flush when the when the system senses a full tank. This occurs when the Water Icon is red.

**Emergency Override**

If the tank is full (Water Icon is red) and an emergency flush is needed do the following.

- ◆ Press and hold either flush button for 6 seconds to flush toilet.

**WARNING**

**This may cause overflowing of the waste tank and system back up. The Diagnostic LED Warning Icon, located on the bottom left corner, will flash.**

**LED Sleep Mode**

To save power consumption when not in use, an automatic LED sleep mode is programmed on this control panel. If the toilet is not used for 8 hours, the keypad's LED lights will go out. The press of any button will start a flush and

reactivate backlighting.

**Cleaning**

The toilet should be cleaned regularly for maximum sanitation and operational efficiency. Clean the toilet bowl with a mild bathroom cleaner. Do not use chlorine or caustic chemicals, such as drain opening types, as they will damage the seals.

Clean out the system by flushing several gallons of fresh water through with one cup of dry laundry detergent. Add odor control deodorant, in the amount specified for your holding tank capacity, after cleaning and every few days during use.

**NOTE**

**Most chemical mixtures for holding tank odor control are poisonous. Follow the product manufacturer's directions and warnings when using any holding tank additive.**

**Maintenance**

To find leaks, check behind or under toilet. Take four or five sheets of toilet tissue and wipe all the water line connections. Start at the top of the unit and work downward. When the tissue comes in contact with leaking water it immediately changes texture.

**NOTE**

**Before storing the motorhome, the toilet must be flushed repeatedly to remove any solids that may have built up.**

**NOTE**

**If the motorhome is in storage for six months it is a good idea to spray silicone on the toilet valve and work it back and forth. Perform this maintenance monthly (silicone will evaporate in about 30 days).**

**Winterization**

The toilet must be winterized to avoid freeze damage. Follow the winterization in Section 6. With the Tecma toilet it is recommended to flush toilet until antifreeze is seen in the bowl. Flush an additional 5 times with the antifreeze mixture to ensure discharge line is winterized.

**Drain Traps & Auto Vents**

Sinks, shower and clothes washer (if equipped) drains incorporate a water trap (P-Trap) and auto vents to prevent waste water holding tank odor from entering the motorhome.

**Drain Traps:**

P-Traps are usually within 54" of a vent tee and must contain water to block odors. During storage water can evaporate and allow odor into motorhome. If odor is detected, run water into sinks, shower and clothes washer to fill P-traps.

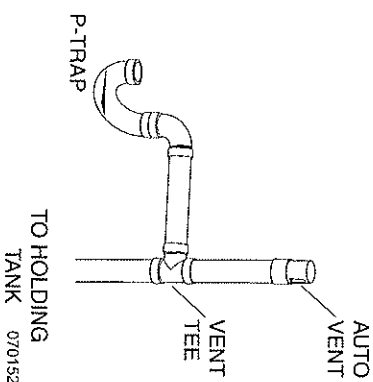

**Auto Vents:**

The auto vent is designed to assist in the smooth flow of water in the drain without creating a vacuum. If stuck in the open position the auto vent can allow grey odors to enter the motorhome. Some auto vents can double as “clean outs” in the event the line needs to be snaked out.

**COLD WEATHER CONDITIONS**

Extended use in below freezing (32° F/0° C) weather will require operation of the furnace to protect interior water lines, fixtures, water storage tanks and pumps. Exposed drains may freeze quickly. If in doubt about what temperature the motorhome will tolerate, winterize with potable antifreeze. Cold temperature can adversely affect water systems below the floor level because the furnace does not provide heat to these components. A 12 Volt bay heater and thermal snap disc are located in the water service bay. The System Heat switch on the monitor panel operates the bay heater and should be turned on when ambient temperatures approach 44° F (+/-6° F) and freezing temperatures occur.

**System Heat Operation:**

1. Systems heat switch is turned **ON** to apply power to the snap disc thermostat.

2. When the bay temperature

reaches 40° F (+/-6° F) the snap

disc thermostat closes. The bay heater and systems heat Active light turns on.

The heater continues to operate until

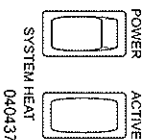

bay temperature reaches 55° F (=/-6° F). The bay heater and Active indicator light will turn **OFF**.

**NOTE**  
The bay heater consumes about 20 Amps when operating.

House batter power can be quickly consumed. It is recommended to hook shore power when using Systems Heat.

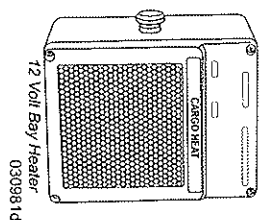
**Cold Weather Storage**

If the motorhome is stored where freezing temperatures may occur, drain the domestic fresh water loop. Begin draining the fresh water tank by opening the low point drain for the fresh tank and allowing the water to drain.

**NOTE**

Icemakers, water filters, water purifiers and water heaters all use domestic water and should be drained and stored in accordance with the manufacturer's recommendation for winterization.

**WINTERIZATION**

Water, plumbing and sewer systems require winterization when the motorhome is placed in storage. The recommended method of winterizing the motorhome is using air pressure to remove liquids that may freeze and cause damage to the various systems and appliances. The lines can then be left empty or filled with an FDA approved RV antifreeze. When plumbing

lines are drained, antifreeze is not necessary, and the decision to use antifreeze is left to the motorhome operator.

**NOTE**  
**ONLY FDA approved RV antifreeze should be used to winterize the water systems in the motorhome.**

**Using Air Pressure**

Access to an air compressor and an adapter to connect the air line regulator to the water system is necessary. Air adapters used for winterizing are available at RV supply locations. Air pressure should not exceed 40 psi. Higher pressure can damage the lines.

1. Empty and flush the holding tanks.
2. Remove water faucet filter cartridge and replace filter with diverter (See “Faucet Water Filter”). With diverter installed it creates a bypass in the water lines.
3. Drain the fresh water tank by opening the fresh water tank drain valve and the fresh water tank low point drain. Both are located in the roadside water service center.
4. Open hot and cold water low-point drains. The low point drains are located in the water service center. Leave low point drains open until the motorhome is used again.
5. Turn the water pump on and allow it to run so that all the water is cleared out of the water pump and water tank.
6. Turn the pump off and close fresh water tank drain valve.

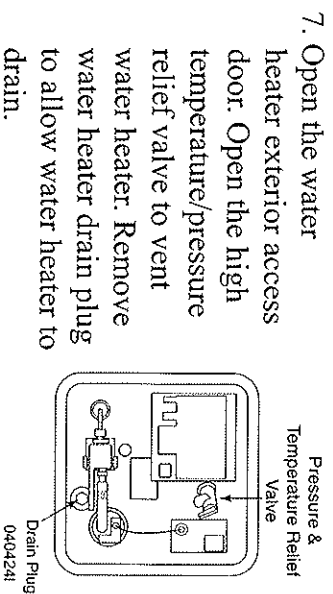

7. Open the water heater exterior access door. Open the high temperature/pressure relief valve to vent water heater. Remove water heater drain plug to allow water heater to drain.
8. After the water is drained connect an air hose to the City/Fresh Water Fill connection. Position the City/Fresh Water Control handle to the “City Water” position. Turn on air compressor. Do not exceed 40 psi in the water lines and faucets.
9. When no further water can be seen coming out of the drains, move water heater bypass valve to BYPASS position. Bypass valve is located on the back of the water heater. Depending on floor plan the back of the water heater can be located in one of several areas. One location is in the bedroom closet. Once inside closet, open door for access to the bypass valve. Another location is in an a curbside compartment. Open the bay door then open the small door to access the bypass valve.

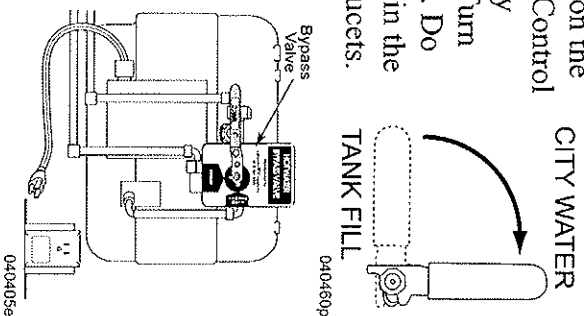

10. Replace the water heater drain plug and close the pressure relief valve.
  11. Open all faucets, including outside faucet and shower, one at a time, to clear water from the water supply lines. Do not forget to drain the shower.
  12. Flush toilet until the water has stopped running.
  13. If applicable, winterize the washer-dryer. (See “Winterizing the Washer-Dryer” in Section 4).
  14. If applicable remove ice maker valve outlet line located in the outside refrigerator access compartment. Cycle ice maker several times to clear water from inlet line and valve. Reconnect ice maker valve outer line.
  15. Shut off the air compressor and disconnect the air hose.
  16. One gallon of FDA approved RV antifreeze is needed to protect various water drain lines in the motorhome. Pour 1 pint into both the kitchen and bath shower drains. Pour 2 pints into the bath sink drain, with some of the antifreeze going into grey tank to protect the drain valve. Open the toilet bowl valve, pour another 3½ pints into the toilet, letting the antifreeze run into the black tank to protect the valve located there. Pour the last pint of antifreeze into the toilet after the toilet bowl valve has been closed.
  17. Use a soft cloth to wipe out the sinks and shower (after the antifreeze is poured in) to protect the surfaces from stains.
  18. Leave the low-point drains open until the motorhome is used again.
- WARNING**  
When draining the low water drain lines and the water heater be sure the water is not hot. Hot water from the lines can burn or injure skin.
- Using Non-Toxic Antifreeze and Gravity Fill**
- Approximately five gallons of FDA approved antifreeze will be required to winterize the motorhome.
1. Empty and flush the holding tanks.
  2. Remove water faucet filter cartridge and replace filter with diverter hose. (See “Faucet Water Filter.”) Diverter hose installed creates a bypass in the water lines.
  3. Drain the fresh water tank by opening the fresh water tank drain valve, water pump shut-off valve, and water tank low point drain and allow water to drain.
  4. Open low-point drain valves and allow water to drain.
  5. Position the City/Fresh Water Control Handle to the “Tank Fill” position.
  6. Turn the water pump on and allow it to run so that all the water is cleared out of the water pump and fresh water tank. Turn the pump off.
  7. Open the water heater exterior access panel. Open the high temperature/pressure relief valve to vent water heater. Remove water heater drain plug to allow water heater to drain.

8. After the water is drained place water heater bypass valve to BYPASS position.
9. Replace the water heater drain plug and close the pressure relief valve.
10. Close the fresh water tank drain valve, water tank low point drain valve, and water pump shut-off valve.
11. Close the low point drain valves.
12. Connect a hose to the Winterization connection and place the other end into the container of antifreeze.
13. Open the winterization valve.  Valve in Tank Fill Position
14. Turn ON the water pump.
15. Open all faucets, one at a time, until a small amount of antifreeze appears.
16. Close the faucets.
17. Open the shower faucets and flush toilet to allow a small amount of antifreeze to run into the holding tanks. Close shower faucets.
18. Use a soft cloth to wipe out the sinks and shower to protect surface from antifreeze stains.
19. Exterior faucet and shower should be opened and closed using the same procedures as the interior faucets.
20. If the motorhome is equipped with an ice maker, remove the valve outlet line located in the outside refrigerator access compartment. Cycle ice maker several times until antifreeze is present.
21. Turn water pump off.

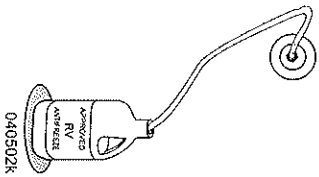

22. Disconnect the power supply line affecting water pump operation.

### Dewinterization

1. Open the fresh water tank drain valve, water tank low point drain valve, and water pump shut off valve.
2. Close fresh water tank drain valve, water tank low point drain valve, and low point drains.
3. Fill the fresh water tank with water.
4. Reconnect the power supply line for the water pump.
5. Turn water pump on and operate all faucets, one at a time, until clear water is present.
6. If applicable, cycle icemaker several times until fresh water is present and reconnect valve outlet line.
7. Install new water faucet filter.
8. Fill water heater with water.

### WARNING

Use only designed non-toxic RV antifreeze for potable water systems. Automotive antifreeze, if ingested, can cause blindness, deafness or death.

### CAUTION

Discard the first two trays of ice from the icemaker. They may contain contaminants.

### WARNING

It is recommended that a qualified RV service technician familiar with motorhomes, such as an authorized dealer, do this procedure.

## WATER SERVICE CENTER

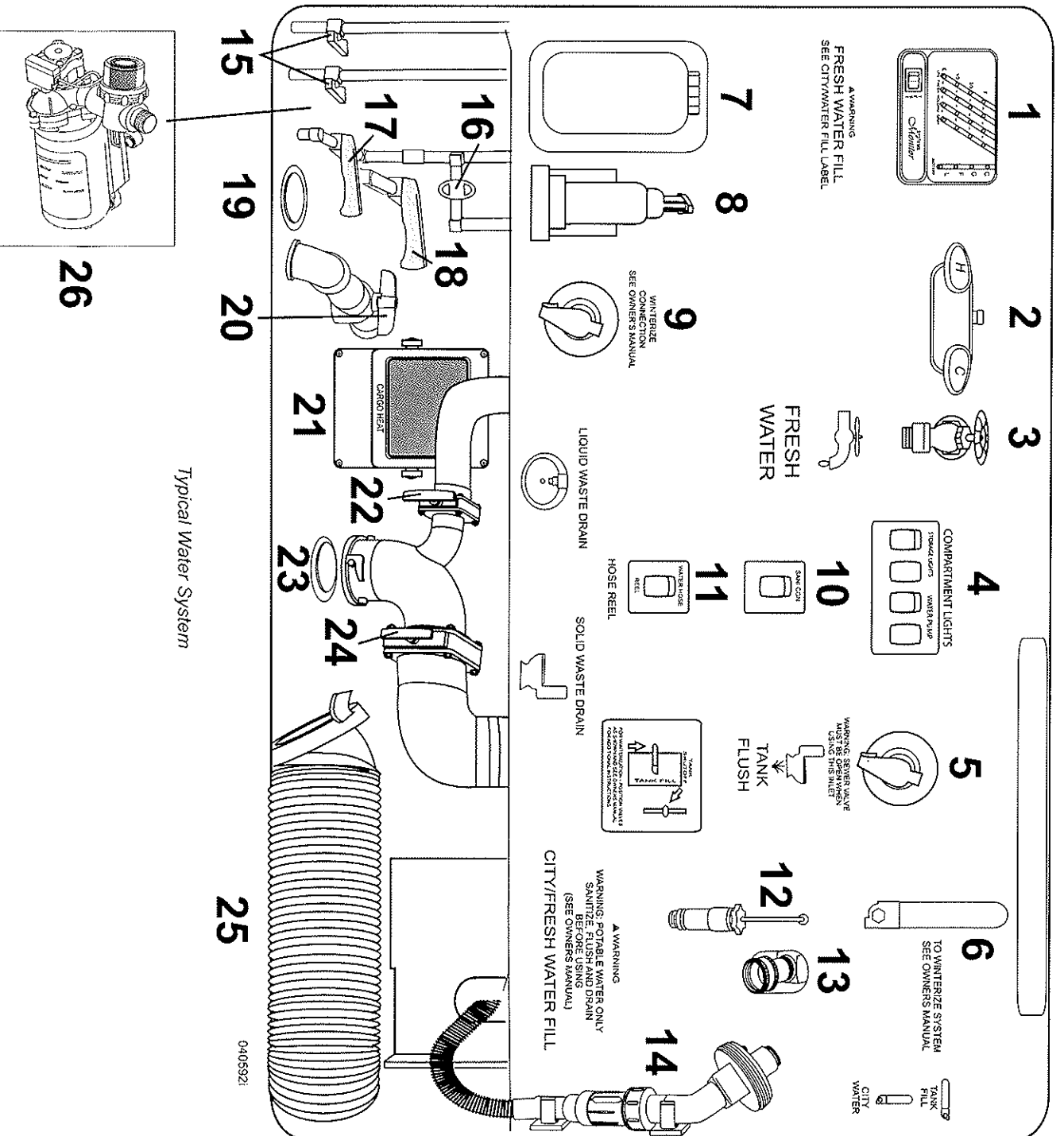

Typical Water System

0405921

1. Tank Monitor Gauge (Optional)
2. Shower
3. Hose faucet
4. Storage Light/Water Pump Switches
5. Sewage Tank Flush Fitting
6. City/Fresh Water Fill Handle
7. Gravity Tank Fill
8. Soap Dispenser
9. Winterize Connection
10. Sani-Con Switch (Optional)
11. Water Hose Reel Switch (Optional)
12. Water Pressure Regulator
13. City/Fresh Water Fill Connection
14. Sani-Con Tank Flush System (Optional)
15. Low Point Drain Valves
16. Winterization Valve
17. Fresh Water Tank Low Point Drain Valve
18. Water Pump Shut-Off Valve
19. Access Port
20. Fresh Water Tank Drain Valve
21. 12 Volt Bay Heater
22. Grey Tank Dump Valve
23. Access Port
24. Black Tank Dump Valve
25. Sewer Hose
26. Water Pump

**NOTE**

Layout of water service center and location of components may vary with floor plans.